

AKCESORIA ■ RH1







Głowica obrotowa do TR1/2/3/6

zalety

- 1 REGULACJA POŁOŻENIA EKRANU pion/poziom
- 2 SOLIDNE WYKONANIE
- 3 REGULACJA WYSOKOŚCI



dane techniczne

			
200x100 mm 200x200 mm 400x200 mm 400x400 mm 600x400 mm	32"-47"	50 Kg	min. 200x100 mm max. 600x400 mm
			
-2°/+14°	192,7 mm	90°-0°	

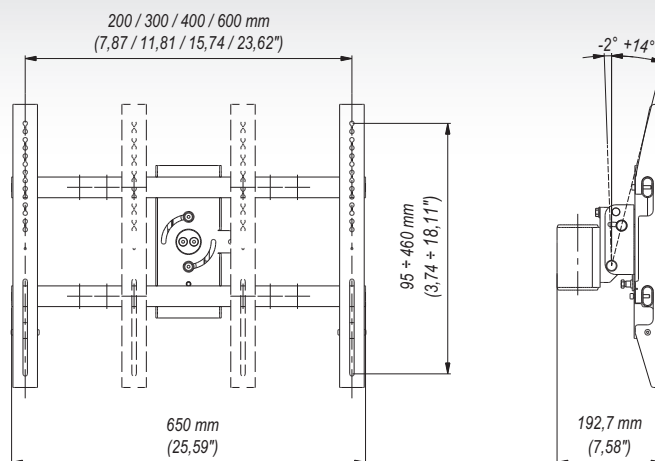

akcesoria

Seria TR



dane handlowe

index	kolor	opakowanie	EAN
RH1c-B	■	■	5908252962761
RH1s-B	■	■	5908252962778

wymiary opakowania [mm] (dł. x szer. x wys.)	650x520x120
Waga Brutto [Kg]	7